

Football Shoot

Airquee
Inflatable
www.airquee.com

A0004



Additional Operating Instructions

Version 1 – November 2023

AQM026



This product can be tested
under the PIPA scheme

Download all
manuals here >>>



These are additional instructions to the Constant Flow Land Inflatable Operation Manual.



The Football Shoot may come in different sizes, colours and shapes. These additional operating instructions cover any device made by Airquee similar to the pictures above.

If you are in any doubt about anything mentioned in this manual or its suitability for your product or circumstances, please contact us using any of the methods given on our website, www.airquee.com/contact.

For all guidance relating to the safe use and operation of an inflatable including safe positioning, anchoring, inflation/deflation, and regular checks please refer to our Constant Flow Land Inflatable Operation Manual. A copy of this can be downloaded by scanning the QR code on the filler pipe of your product or by visiting www.airquee.com/manuals.



As owner/operator it is your responsibility to write and carry out your own risk assessment before attempting to use this product. This manual, together with the Constant Flow Land Inflatable Operation Manual must be read before attempting to setup/use the product.

Additional Equipment Needed

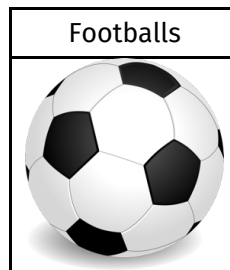

- The above equipment is not supplied with the game.



This inflatable can be set up and packed away by 1 person who have had proper manual handling training and use the correct equipment to move the inflatable. You should conduct your own manual handling risk assessment to determine a safe set up procedure and number of people required based on your circumstances.

This inflatable uses a 1.5hp fan and should operate at a minimum pressure of 1Kpa.

For information regarding dimensions, weight, zips, filler pipes etc please refer the test certificate emailed to you.

INTENDED USE OF THE PRODUCT

An inflatable football shootout game serves as an engaging and entertaining activity designed to challenge participants' accuracy and kicking skills. The primary purpose is to provide a recreational platform where players can test their football abilities, aiming to score goals by kicking a football into target areas or through designated openings in an inflatable structure. This game fosters healthy competition, encouraging participants to improve their aim, precision, and power in a fun and dynamic environment. It not only promotes physical activity but also enhances hand-eye coordination, teamwork, and friendly rivalry, making it an enjoyable experience for individuals and groups, whether for leisure or organised events.

OPERATING GUIDELINES/RULES OF PLAY

- **Users should NOT be allowed to climb on the inflatable.**
- **If used outdoors then it must be used in accordance with maximum wind speed of 24mph – Beauford Scale 5. More information is available in section 10 of the Constant Flow Land Manual.**
- **Only one player should use the game at a time.**
- **Players of any age or ability can use this game provided they can safely handle and kick the ball to reach the targets.**
- **Younger children or less able people may require assistance.**
- **The operator should determine the distance to stand from the targets. This will vary according to age/size/ability of the user.**

For more information regarding operating guidelines and general rules of play please see the Constant Flow Land Inflatable Operation Manual.

SETUP / PACK AWAY

For setup and packing away of this inflatable please follow the standard guidelines in the Constant Flow Land Manual and adhere to all instructions relating to manual handling, positioning, anchoring etc.

Inspect all accessories to ensure they have not become, broken, sharp, or damaged in any way that may be unsafe to use. Accessories will wear over time, and it is recommended to keep a spare set ready to be used in case damage is identified.

In addition to the checks that you must perform, all inflatables require an annual inspection. Please refer to local legislation for the specific requirements of the country or region that you are operating in.

TECHNICAL DETAILS

- All fabrics flame retardant.
- Min tear strength warp 400N, weft 350N (test method Annex E EN14960)
- Min tensile strength warp 2250N weft 1850N (EN ISO 1421:1998)
- Min adhesion 100N (EN 2411:2000) Threads Min 88N tensile strength
- Thread is non-rotting yarn and at least 88 N tensile strength. Stitching is lock-stitch. The length of individual stitches is a minimum of 3 mm and a maximum of 8 mm.
- Each anchor point can withstand a minimum of 1600N

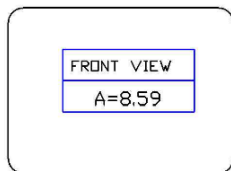
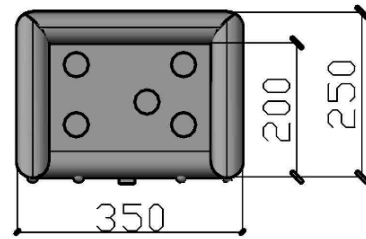
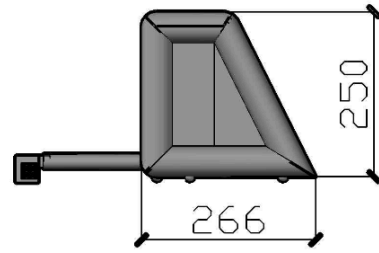
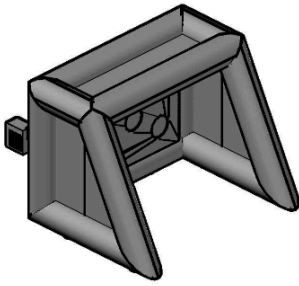

$$\frac{114.5853 \times 8.59}{1600N} \times 1.5$$

= 0.91 (must round up)

= 1 anchors on the front and back

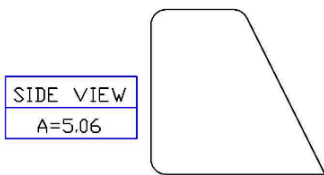
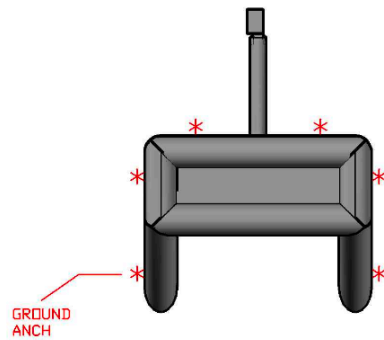

$$\frac{114.5853 \times 5.06}{1600N} \times 1.5$$

= 0.54 (must round up)

= 1 anchors on left and right sides

NO OF ANCHOR PLACED BY AIRQUEE: 6	
GROUND: 6	HIGH LEVEL: -

ACCORDING TO CALCULATIONS: 4

The Airquee Operation Manual (the "Manual") is proprietary to Airquee Ltd, SC Airquee SRL, Airquee Northern Ireland Limited and Airquee Ireland Limited collectively known as ("Airquee") and no ownership rights are hereby transferred. No part of the Manual shall be used, reproduced, translated, converted, adapted, stored in a retrieval system, communicated, or transmitted by any means, for any commercial purpose, including without limitation, sale, resale, licence, rental, or lease, without the prior express written consent of Airquee.

Airquee does not make any representations, warranties, or guarantees, express or implied, as to the accuracy or completeness of the Manual. Users must be aware that updates and amendments will be made from time to time to the Manual. It is the user's responsibility to determine whether there have been any such updates or amendments. Neither Airquee nor any of its directors, officers, employees, or agents shall be liable in contract, tort or in any other manner whatsoever to any person for any loss, damage, injury, liability, cost or expense of any nature, including without limitation incidental, special, direct or consequential damages arising out of or in connection with the use of the Manual. All logos, images and content not owned by Airquee are copyright to their respective owners and have been reproduced by permission.

Your product model, and its additional equipment (number and type) may differ from the one presented in this manual. All the pictures and drawings contained in this manual are for illustration purposes only. Any misuse or failure to adhere to the instructions and recommendations contained in this manual will render void the warranty.

Due to constant innovation, product enhancement and changes to international standards any printed or downloaded manual may become out of date. The most recent manuals can be freely downloaded at www.airquee.com/manuals.

For any further information or guidance please refer to www.airquee.com/contact for the best way to contact us in your country or region.

